



Ultrasonic sensor

UB4000-30GM-H3-4DT04

- Separate evaluation
- Direct detection mode

Single head system



Dimensions

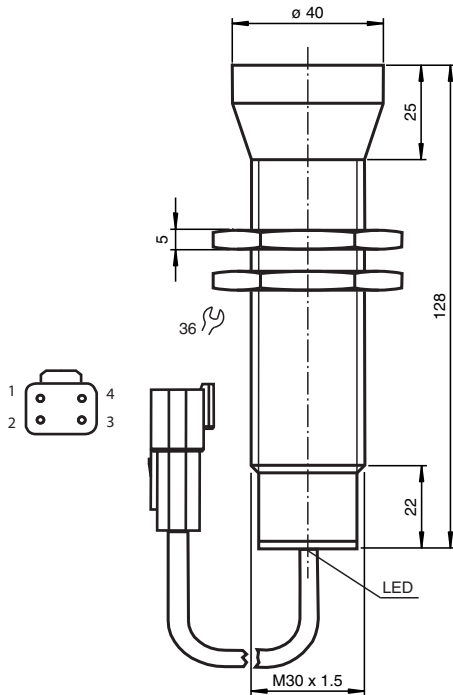

Technical Data

General specifications

Sensing range	200 ... 4000 mm
Adjustment range	240 ... 4000 mm
Dead band	0 ... 200 mm ¹⁾
Standard target plate	100 mm x 100 mm
Transducer frequency	approx. 85 kHz

Electrical specifications

Operating voltage	U_B	10 ... 30 V DC , ripple 10 % _{SS}
No-load supply current	I_0	≤ 30 mA

Input

Release date: 2020-03-23 Date of issue: 2021-02-05 Filename: 911811_eng.pdf

Refer to "General Notes Relating to Pepperl+Fuchs Product Information".

Pepperl+Fuchs Group
www.pepperl-fuchs.com

USA: +1 330 486 0001
fa-info@us.pepperl-fuchs.com

Germany: +49 621 776 1111
fa-info@de.pepperl-fuchs.com

Singapore: +65 6779 9091
fa-info@sg.pepperl-fuchs.com

PF PEPPERL+FUCHS

Technical Data

Input type		1 pulse input for transmitter pulse (clock) 0-level (active): < 5 V ($U_B > 15\text{ V}$) 1-level (inactive): > 10 V ... + U_B ($U_B > 15\text{ V}$) 0-level (active): < 1/3 U_B ($10\text{ V} < U_B < 15\text{ V}$) 1-level (inactive): > 2/3 U_B ... + U_B ($10\text{ V} < U_B < 15\text{ V}$)
Pulse length		40 ... 600 μs (typ. 500 μs) ²⁾
Pause length		$\geq 50 \times$ pulse length
Impedance		10 kOhm internal connected to + U_B
Output		
Output type		1 pulse output for echo run time, short-circuit proof open collector PNP with pulldown resistor = 22 kOhm level 0 (no echo): - U_B level 1 (echo detected): $\geq (+U_B - 2\text{ V})$
Rated operating current	I_e	15 mA , short-circuit/overload protected
Temperature influence		the echo propagation time: 0.17 % / K
Compliance with standards and directives		
Standard conformity		
Standards		EN 60947-5-2:2007 IEC 60947-5-2:2007
Approvals and certificates		
UL approval		cULus Listed, General Purpose
CSA approval		cCSAus Listed, General Purpose
Ambient conditions		
Ambient temperature		-25 ... 85 °C (-13 ... 185 °F)
Storage temperature		-40 ... 85 °C (-40 ... 185 °F)
Mechanical specifications		
Degree of protection		IP67
Connection		Deutsch connector, 4-pin DT-04-4P with 300 mm (1 ft) cable
Material		
Housing		stainless steel (1.4305 / AISI 303) PBT plastic parts
Transducer		epoxy resin/hollow glass sphere mixture; polyurethane foam
Mass		210 g
General information		
Supplementary information		Only the sensor has UL approval.

Connection

Standard symbol/Connection:

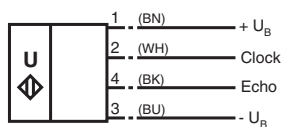

2 = Emitter pulse input
4 = Echo propagation time output
Core colors in accordance with EN 60947-5-2.

Connection Assignment

Connector 4DT04

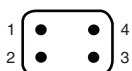

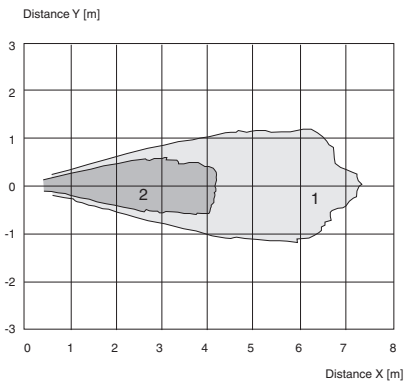

Characteristic Curve

Characteristic response curves



Curve 1: flat surface 100 mm x 100 mm
 Curve 2: round bar, Ø 25 mm

Accessories

	<p>BF 30</p>	<p>Mounting flange, 30 mm</p>
	<p>BF 5-30</p>	<p>Universal mounting bracket for cylindrical sensors with a diameter of 5 ... 30 mm</p>

Release date: 2020-03-23 Date of issue: 2021-02-05 Filename: 911811_eng.pdf

Function Principle

The sensing range is determined in the downstream evaluation electronics such as PLC modules or other existing evaluation units.

The object distance in pulse-echo mode is obtained from the echo time Δt . The emission of an ultrasonic pulse starts simultaneously with the falling slope of the clock input signal.

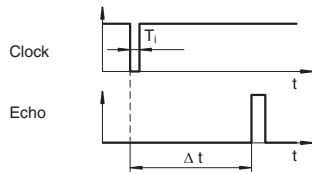

We recommend the usage of a npn-transistor to trigger the sensors clock input. The sensors clock input is connected to the $+U_B$ potential internally by means of a pull up resistor.

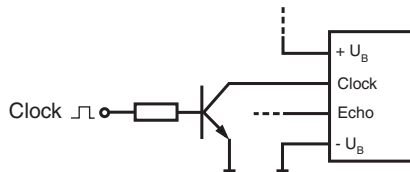

- 1) The unusable area (blind range) BR depends on the pulse duration T_i .
The unusable area reaches a minimum with the shortest pulse duration.
- 2) The sensors detection range depends on the pulse duration T_i .
With pulse duration < typical pulse duration, the sensors detection range may be reduced.