

# Ultrasonic sensor

## UB800-18GM40-E5-V1-Y295127



- Short design, 40 mm
- Function indicators visible from all directions
- Switch output
- 5 different output functions can be set
- Program input
- Temperature compensation
- Custom configuration

Single head system



### Dimensions

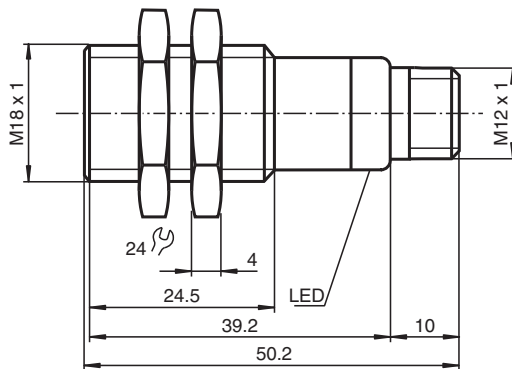

### Technical Data

#### General specifications

Sensing range	50 ... 800 mm
Adjustment range	70 ... 800 mm
Dead band	0 ... 50 mm
Standard target plate	100 mm x 100 mm
Transducer frequency	approx. 255 kHz
Response delay	approx. 100 ms

#### Indicators/operating means

LED green	Power on
LED yellow	indication of the switching state flashing: program function object detected

Release date: 2021-02-25 Date of issue: 2021-02-25 Filename: 295127\_eng.pdf

Refer to "General Notes Relating to Pepperl+Fuchs Product Information".

Pepperl+Fuchs Group  
www.pepperl-fuchs.com

USA: +1 330 486 0001  
fa-info@us.pepperl-fuchs.com

Germany: +49 621 776 1111  
fa-info@de.pepperl-fuchs.com

Singapore: +65 6779 9091  
fa-info@sg.pepperl-fuchs.com

PEPPERL+FUCHS

## Technical Data

LED red		solid red: Error red, flashing: program function, object not detected
<b>Electrical specifications</b>		
Operating voltage	$U_B$	10 ... 30 V DC , ripple 10 % <sub>SS</sub>
No-load supply current	$I_0$	≤ 20 mA
<b>Input</b>		
Input type		1 program input operating distance 1: $-U_B \dots +1$ V, operating distance 2: $+6$ V ... $+U_B$ input impedance: > 4,7 kΩ program pulse: ≥ 1 s
<b>Output</b>		
Output type		1 switching output E5, PNP NO/NC, programmable
Rated operating current	$I_e$	200 mA , short-circuit/overload protected
Default setting		Switch point A1: 800 mm , Switch point A2: 70 mm NC contact
Voltage drop	$U_d$	≤ 3 V
Repeat accuracy		≤ 1 %
Switching frequency	f	≤ 4 Hz
Range hysteresis	H	1 % of the set operating distance
Temperature influence		± 1.5 % of full-scale value
<b>Compliance with standards and directives</b>		
Standard conformity		
Standards		EN 60947-5-2:2007+A1:2012 IEC 60947-5-2:2007 + A1:2012
<b>Approvals and certificates</b>		
EAC conformity		TR CU 020/2011 TR CU 037/2016
UL approval		cULus Listed, General Purpose
CSA approval		cCSAus Listed, General Purpose
CCC approval		CCC approval / marking not required for products rated ≤36 V
<b>Ambient conditions</b>		
Ambient temperature		-25 ... 70 °C (-13 ... 158 °F)
Storage temperature		-40 ... 85 °C (-40 ... 185 °F)
<b>Mechanical specifications</b>		
Connection type		Connector plug M12 x 1 , 4-pin
Degree of protection		IP67
Material		
Housing		brass, nickel-plated
Transducer		epoxy resin/hollow glass sphere mixture; foam polyurethane, cover PBT
Mass		25 g

## Connection

Standard symbol/Connections:  
(version E5, pnp)

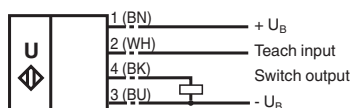

Core colours in accordance with EN 60947-5-2.

## Connection Assignment

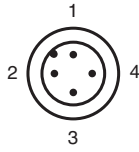

Wire colors in accordance with EN 60947-5-2

1	BN	(brown)
2	WH	(white)
3	BU	(blue)
4	BK	(black)

## Characteristic Curve

### Characteristic response curve

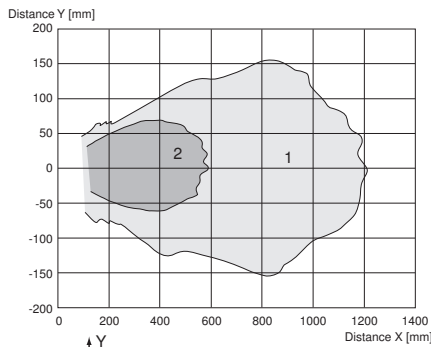

Curve 1: flat surface 100 mm x 100 mm  
Curve 2: round bar, Ø 25 mm

## Programming

### Programmable output modes







- Window mode, normally open mode  
 $A1 < A2$ : object distance →
- Window mode, normally closed mode  
 $A2 < A1$ :
- One switch point, normally open mode  
 $A1 \rightarrow \infty$ :
- One switch point, normally closed mode  
 $A2 \rightarrow \infty$ :
- $A1 \rightarrow \infty, A2 \rightarrow \infty$ : Object presence detection mode  
 Object detected: Switch output closed  
 No object detected: Switch output open

## Accessories

	<b>UB-PROG2</b>	Programming unit
--	-----------------	------------------

Release date: 2021-02-25 Date of issue: 2021-02-25 Filename: 295127\_eng.pdf

**Accessories**

	<b>OMH-04</b>	Mounting aid for round steel ø 12 mm or sheet 1.5 mm ... 3 mm
	<b>BF 18</b>	Mounting flange, 18 mm
	<b>BF 18-F</b>	Plastic mounting adapter, 18 mm
	<b>BF 5-30</b>	Universal mounting bracket for cylindrical sensors with a diameter of 5 ... 30 mm
	<b>V1-G-2M-PVC</b>	Female cordset single-ended M12 straight A-coded, 4-pin, PVC cable grey
	<b>V1-W-2M-PUR</b>	Female cordset single-ended M12 angled A-coded, 4-pin, PUR cable grey

Release date: 2021-02-25 Date of issue: 2021-02-25 Filename: 295127\_eng.pdf

Refer to "General Notes Relating to Pepperl+Fuchs Product Information".

Pepperl+Fuchs Group  
www.pepperl-fuchs.com

USA: +1 330 486 0001  
fa-info@us.pepperl-fuchs.com

Germany: +49 621 776 1111  
fa-info@de.pepperl-fuchs.com

Singapore: +65 6779 9091  
fa-info@sg.pepperl-fuchs.com

## Teach-In

### Adjusting the switching points

The ultrasonic sensor features a switch output with two teachable switching points. These are set by applying the supply voltage  $-U_B$  or  $+U_B$  to the TEACH-IN input. The supply voltage must be applied to the TEACH-IN input for at least 1 s. LEDs indicate whether the sensor has recognised the target during the TEACH-IN procedure. Switching point A1 is taught with  $-U_B$ , A2 with  $+U_B$ .

Five different output functions can be set

1. Window mode, normally-open function
2. Window mode, normally-closed function
3. one switching point, normally-open function
4. one switching point, normally-closed function
5. Detection of object presence

#### TEACH-IN window mode, normally-open function

- Set target to near switching point
- TEACH-IN switching point A1 with  $-U_B$
- Set target to far switching point
- TEACH-IN switching point A2 with  $+U_B$

#### TEACH-IN window mode, normally-closed function

- Set target to near switching point
- TEACH-IN switching point A2 with  $+U_B$
- Set target to far switching point
- TEACH-IN switching point A1 with  $-U_B$

#### TEACH-IN switching point, normally-open function

- Set target to near switching point
- TEACH-IN switching point A2 with  $+U_B$
- Cover sensor with hand or remove all objects from sensing range
- TEACH-IN switching point A1 with  $-U_B$

#### TEACH-IN switching point, normally-closed function

- Set target to near switching point
- TEACH-IN switching point A1 with  $-U_B$
- Cover sensor with hand or remove all objects from sensing range
- TEACH-IN switching point A2 with  $+U_B$

#### TEACH-IN detection of objects presence

- Cover sensor with hand or remove all objects from sensing range
- TEACH-IN switching point A1 with  $-U_B$
- TEACH-IN switching point A2 with  $+U_B$

### LED Displays

Displays in dependence on operating mode	Red LED	Yellow LED
<b>TEACH-IN switching point:</b>		
Object detected	off	flashes
No object detected	flashes	off
Object uncertain (TEACH-IN invalid)	On	off
Normal operation	off	Switching state
Fault	on	Previous state

## Installation Conditions

If the sensor is installed at places, where the environment temperature can fall below 0 °C, for the sensors fixation, one of the mounting flanges BF18, BF18-F or BF 5-30 must be used.

In case of direct mounting of the sensor in a through hole using the steel nuts, it has to be fixed at the middle of the housing thread. If a fixation at the front end of the threaded housing is required, plastic nuts with centering ring (accessories) must be used.

Release date: 2021-02-25 Date of issue: 2021-02-25 Filename: 295127\_eng.pdf