

Ultrasonic sensor

UB800-18GM60A-E5-V1-M



- Short version: 55 mm
- Function indicators visible from all directions
- Switch output
- 5 different output functions can be set
- Program input
- Temperature compensation
- E1-Type approval

Single head system



Dimensions

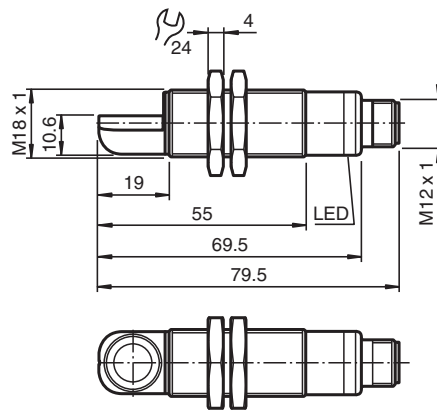

Technical Data

General specifications

Sensing range	50 ... 800 mm
Adjustment range	70 ... 800 mm
Dead band	0 ... 50 mm
Standard target plate	100 mm x 100 mm
Transducer frequency	approx. 255 kHz
Response delay	approx. 100 ms

Indicators/operating means

LED green	Power on
LED yellow	indication of the switching state flashing: program function object detected
LED red	solid red: Error red, flashing: program function, object not detected

Electrical specifications

Operating voltage	U_B	10 ... 30 V DC , ripple 10 % _{SS}
No-load supply current	I_0	≤ 20 mA

Input

Release date: 2020-03-24 Date of issue: 2021-02-05 Filename: 288383_eng.pdf

Refer to "General Notes Relating to Pepperl+Fuchs Product Information".

Pepperl+Fuchs Group
www.pepperl-fuchs.com

USA: +1 330 486 0001
fa-info@us.pepperl-fuchs.com

Germany: +49 621 776 1111
fa-info@de.pepperl-fuchs.com

Singapore: +65 6779 9091
fa-info@sg.pepperl-fuchs.com

 **PEPPERL+FUCHS**

Technical Data

Input type	1 program input operating distance 1: $-U_B \dots +1 \text{ V}$, operating distance 2: $+6 \text{ V} \dots +U_B$ input impedance: $> 4,7 \text{ k}\Omega$ program pulse: $\geq 1 \text{ s}$	
Output		
Output type	1 switching output E5, PNP NO/NC, programmable	
Rated operating current	I_e	200 mA , short-circuit/overload protected
Default setting	Switch point A1: 70 mm Switch point A2: 800 mm	
Voltage drop	U_d	$\leq 3 \text{ V}$
Repeat accuracy	$\leq 1 \%$	
Switching frequency	f	$\leq 4 \text{ Hz}$
Range hysteresis	H	1 % of the set operating distance
Temperature influence	$\pm 1.5 \%$ of full-scale value	
Compliance with standards and directives		
Standard conformity		
Standards	EN 60947-5-2:2007 + A1:2012 IEC 60947-5-2:2007 + A1:2012	
Approvals and certificates		
UL approval	cULus Listed, General Purpose	
CSA approval	cCSAus Listed, General Purpose	
CCC approval	CCC approval / marking not required for products rated $\leq 36 \text{ V}$	
UN/ECE Regulation No. 10 (E1)	Type-approval number: 10R-058090	
Ambient conditions		
Ambient temperature	$-25 \dots 70 \text{ }^\circ\text{C}$ ($-13 \dots 158 \text{ }^\circ\text{F}$)	
Storage temperature	$-40 \dots 85 \text{ }^\circ\text{C}$ ($-40 \dots 185 \text{ }^\circ\text{F}$)	
Mechanical specifications		
Connection type	Connector M12 x 1 , 4-pin	
Degree of protection	IP67	
Material		
Housing	brass, nickel-plated	
Transducer	epoxy resin/hollow glass sphere mixture; foam polyurethane, cover PBT	
Mass	32 g	

Connection

Standard symbol/Connections:
(version E5, pnp)

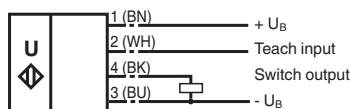

Core colours in accordance with EN 60947-5-2.

Connection Assignment

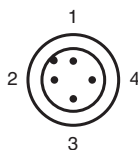

Release date: 2020-03-24 Date of issue: 2021-02-05 Filename: 288383_eng.pdf

Wire colors in accordance with EN 60947-5-2

1	BN	(brown)
2	WH	(white)
3	BU	(blue)
4	BK	(black)

Characteristic Curve

Characteristic response curve

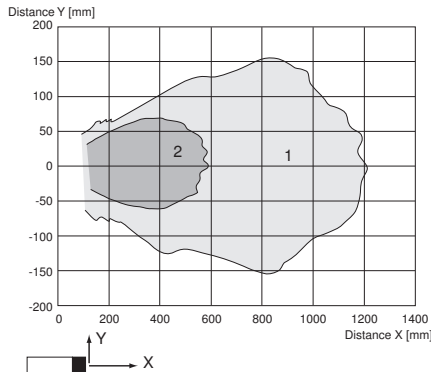

Curve 1: flat surface 100 mm x 100 mm
Curve 2: round bar, Ø 25 mm

Programming

Programmable output modes

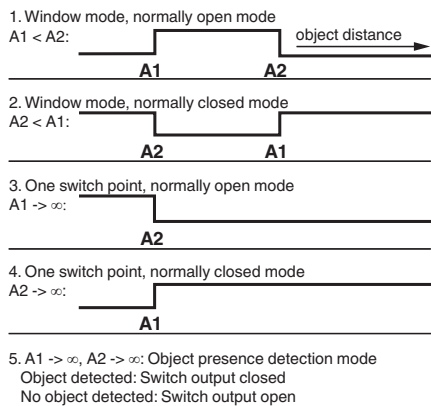

Accessories

	UB-PROG2	Programming unit
	OMH-04	Mounting aid for round steel ϕ 12 mm or sheet 1.5 mm ... 3 mm
	BF 18	Mounting flange, 18 mm
	BF 18-F	Plastic mounting adapter, 18 mm

Release date: 2020-03-24 Date of issue: 2021-02-05 Filename: 288383_eng.pdf

Refer to "General Notes Relating to Pepperl+Fuchs Product Information".



Pepperl+Fuchs Group
www.pepperl-fuchs.com

USA: +1 330 486 0001
fa-info@us.pepperl-fuchs.com

Germany: +49 621 776 1111
fa-info@de.pepperl-fuchs.com

Singapore: +65 6779 9091
fa-info@sg.pepperl-fuchs.com

Accessories

	<p>BF 5-30</p>	<p>Universal mounting bracket for cylindrical sensors with a diameter of 5 ... 30 mm</p>
	<p>V1-G-2M-PVC</p>	<p>Female cordset single-ended M12 straight A-coded, 4-pin, PVC cable grey</p>
	<p>V1-W-2M-PUR</p>	<p>Female cordset single-ended M12 angled A-coded, 4-pin, PUR cable grey</p>

Release date: 2020-03-24 Date of issue: 2021-02-05 Filename: 288383_eng.pdf

Refer to "General Notes Relating to Pepperl+Fuchs Product Information".

Pepperl+Fuchs Group
www.pepperl-fuchs.com

USA: +1 330 486 0001
fa-info@us.pepperl-fuchs.com

Germany: +49 621 776 1111
fa-info@de.pepperl-fuchs.com

Singapore: +65 6779 9091
fa-info@sg.pepperl-fuchs.com

Teach-In

Adjusting the switching points

The ultrasonic sensor features a switch output with two teachable switching points. These are set by applying the supply voltage $-U_B$ or $+U_B$ to the TEACH-IN input. The supply voltage must be applied to the TEACH-IN input for at least 1 s. LEDs indicate whether the sensor has recognised the target during the TEACH-IN procedure. Switching point A1 is taught with $-U_B$, A2 with $+U_B$.

Five different output functions can be set

1. Window mode, normally-open function
2. Window mode, normally-closed function
3. one switching point, normally-open function
4. one switching point, normally-closed function
5. Detection of object presence

TEACH-IN window mode, normally-open function

- Set target to near switching point
- TEACH-IN switching point A1 with $-U_B$
- Set target to far switching point
- TEACH-IN switching point A2 with $+U_B$

TEACH-IN window mode, normally-closed function

- Set target to near switching point
- TEACH-IN switching point A2 with $+U_B$
- Set target to far switching point
- TEACH-IN switching point A1 with $-U_B$

TEACH-IN switching point, normally-open function

- Set target to near switching point
- TEACH-IN switching point A2 with $+U_B$
- Cover sensor with hand or remove all objects from sensing range
- TEACH-IN switching point A1 with $-U_B$

TEACH-IN switching point, normally-closed function

- Set target to near switching point
- TEACH-IN switching point A1 with $-U_B$
- Cover sensor with hand or remove all objects from sensing range
- TEACH-IN switching point A2 with $+U_B$

TEACH-IN detection of objects presence

- Cover sensor with hand or remove all objects from sensing range
- TEACH-IN switching point A1 with $-U_B$
- TEACH-IN switching point A2 with $+U_B$

LED Displays

Displays in dependence on operating mode	Red LED	Yellow LED
TEACH-IN switching point:		
Object detected	off	flashes
No object detected	flashes	off
Object uncertain (TEACH-IN invalid)	On	off
Normal operation	off	Switching state
Fault	on	Previous state

Release date: 2020-03-24 Date of issue: 2021-02-05 Filename: 288383_eng.pdf