

# Ultrasonic sensor

## UB300-18GM60A-E5-V1-M



- Short version: 55 mm
- Function indicators visible from all directions
- Switch output
- 5 different output functions can be set
- Program input
- Temperature compensation
- E1-Type approval

Single head system



### Dimensions

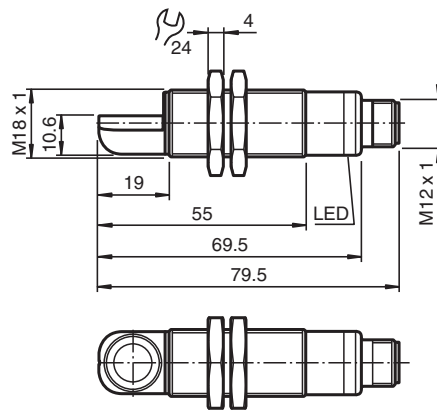

### Technical Data

#### General specifications

Sensing range	35 ... 300 mm
Adjustment range	50 ... 300 mm
Dead band	0 ... 35 mm
Standard target plate	100 mm x 100 mm
Transducer frequency	approx. 390 kHz
Response delay	approx. 50 ms

#### Indicators/operating means

LED green	Power on
LED yellow	indication of the switching state flashing: program function object detected
LED red	solid red: Error red, flashing: program function, object not detected

#### Electrical specifications

Operating voltage	$U_B$	10 ... 30 V DC, ripple 10 % <sub>SS</sub>
No-load supply current	$I_0$	≤ 20 mA

#### Input

Release date: 2020-03-24 Date of issue: 2021-02-05 Filename: 288381\_eng.pdf

Refer to "General Notes Relating to Pepperl+Fuchs Product Information".

Pepperl+Fuchs Group  
www.pepperl-fuchs.com

USA: +1 330 486 0001  
fa-info@us.pepperl-fuchs.com

Germany: +49 621 776 1111  
fa-info@de.pepperl-fuchs.com

Singapore: +65 6779 9091  
fa-info@sg.pepperl-fuchs.com

**PF** PEPPERL+FUCHS

## Technical Data

Input type	1 program input operating distance 1: $-U_B \dots +1 \text{ V}$ , operating distance 2: $+6 \text{ V} \dots +U_B$ input impedance: $> 4,7 \text{ k}\Omega$ program pulse: $\geq 1 \text{ s}$	
<b>Output</b>		
Output type	1 switching output E5, PNP NO/NC, programmable	
Rated operating current	$I_e$	200 mA , short-circuit/overload protected
Default setting	Switch point A1: 50 mm Switch point A2: 300 mm	
Voltage drop	$U_d$	$\leq 3 \text{ V}$
Repeat accuracy	$\leq 1 \%$	
Switching frequency	$f$	$\leq 13 \text{ Hz}$
Range hysteresis	$H$	1 % of the set operating distance
Temperature influence	$\pm 1.5 \%$ of full-scale value	
<b>Compliance with standards and directives</b>		
Standard conformity		
Standards	EN 60947-5-2:2007 + A1:2012 IEC 60947-5-2:2007 + A1:2012	
<b>Approvals and certificates</b>		
UL approval	cULus Listed, General Purpose	
CSA approval	cCSAus Listed, General Purpose	
CCC approval	CCC approval / marking not required for products rated $\leq 36 \text{ V}$	
UN/ECE Regulation No. 10 (E1)	Type-approval number: 10R-058090	
<b>Ambient conditions</b>		
Ambient temperature	$-25 \dots 70 \text{ }^\circ\text{C}$ ( $-13 \dots 158 \text{ }^\circ\text{F}$ )	
Storage temperature	$-40 \dots 85 \text{ }^\circ\text{C}$ ( $-40 \dots 185 \text{ }^\circ\text{F}$ )	
<b>Mechanical specifications</b>		
Connection type	Connector M12 x 1 , 4-pin	
Degree of protection	IP67	
Material		
Housing	brass, nickel-plated	
Transducer	epoxy resin/hollow glass sphere mixture; foam polyurethane, cover PBT	
Mass	32 g	

## Connection

Standard symbol/Connections:  
(version E5, pnp)

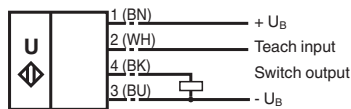

Core colours in accordance with EN 60947-5-2.

## Connection Assignment

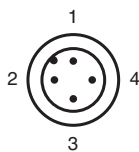

Wire colors in accordance with EN 60947-5-2

1	BN	(brown)
2	WH	(white)
3	BU	(blue)
4	BK	(black)

## Characteristic Curve

### Characteristic response curve

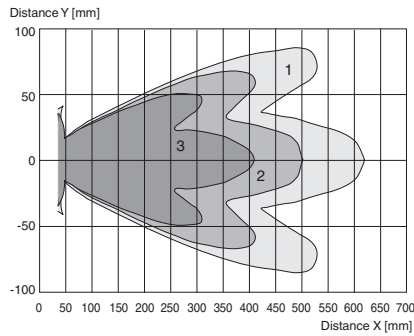

Curve 1: flat surface 100 mm x 100 mm  
 Curve 2: flat surface 10 mm x 10 mm  
 Curve 3: round bar, Ø 25 mm

## Programming

### Programmable output modes

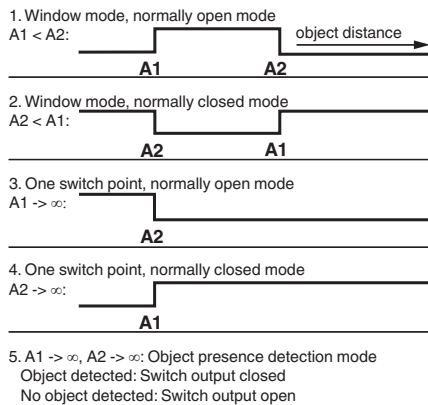



## Accessories

	<b>UB-PROG2</b>	Programming unit
	<b>OMH-04</b>	Mounting aid for round steel $\varnothing$ 12 mm or sheet 1.5 mm ... 3 mm
	<b>BF 18</b>	Mounting flange, 18 mm
	<b>BF 18-F</b>	Plastic mounting adapter, 18 mm
	<b>BF 5-30</b>	Universal mounting bracket for cylindrical sensors with a diameter of 5 ... 30 mm

Release date: 2020-03-24 Date of issue: 2021-02-05 Filename: 288381\_eng.pdf

**Accessories**

	<p><b>V1-G-2M-PVC</b></p>	<p>Female cordset single-ended M12 straight A-coded, 4-pin, PVC cable grey</p>
	<p><b>V1-W-2M-PUR</b></p>	<p>Female cordset single-ended M12 angled A-coded, 4-pin, PUR cable grey</p>

Release date: 2020-03-24 Date of issue: 2021-02-05 Filename: 288381\_eng.pdf

Refer to "General Notes Relating to Pepperl+Fuchs Product Information".

Pepperl+Fuchs Group  
www.pepperl-fuchs.com

USA: +1 330 486 0001  
fa-info@us.pepperl-fuchs.com

Germany: +49 621 776 1111  
fa-info@de.pepperl-fuchs.com

Singapore: +65 6779 9091  
fa-info@sg.pepperl-fuchs.com

**Teach-In**

**Adjusting the switching points**

The ultrasonic sensor features a switch output with two teachable switching points. These are set by applying the supply voltage  $-U_B$  or  $+U_B$  to the TEACH-IN input. The supply voltage must be applied to the TEACH-IN input for at least 1 s. LEDs indicate whether the sensor has recognised the target during the TEACH-IN procedure. Switching point A1 is taught with  $-U_B$ , A2 with  $+U_B$ .

Five different output functions can be set

1. Window mode, normally-open function
2. Window mode, normally-closed function
3. one switching point, normally-open function
4. one switching point, normally-closed function
5. Detection of object presence

**TEACH-IN window mode, normally-open function**

- Set target to near switching point
- TEACH-IN switching point A1 with  $-U_B$
- Set target to far switching point
- TEACH-IN switching point A2 with  $+U_B$

**TEACH-IN window mode, normally-closed function**

- Set target to near switching point
- TEACH-IN switching point A2 with  $+U_B$
- Set target to far switching point
- TEACH-IN switching point A1 with  $-U_B$

**TEACH-IN switching point, normally-open function**

- Set target to near switching point
- TEACH-IN switching point A2 with  $+U_B$
- Cover sensor with hand or remove all objects from sensing range
- TEACH-IN switching point A1 with  $-U_B$

**TEACH-IN switching point, normally-closed function**

- Set target to near switching point
- TEACH-IN switching point A1 with  $-U_B$
- Cover sensor with hand or remove all objects from sensing range
- TEACH-IN switching point A2 with  $+U_B$

**TEACH-IN detection of objects presence**

- Cover sensor with hand or remove all objects from sensing range
- TEACH-IN switching point A1 with  $-U_B$
- TEACH-IN switching point A2 with  $+U_B$

**LED Displays**

Displays in dependence on operating mode	Red LED	Yellow LED
<b>TEACH-IN switching point:</b>		
Object detected	off	flashes
No object detected	flashes	off
Object uncertain (TEACH-IN invalid)	On	off
Normal operation	off	Switching state
Fault	on	Previous state

Release date: 2020-03-24 Date of issue: 2021-02-05 Filename: 288381\_eng.pdf