



## Ultrasonic sensor UC250-F77-EP-IO-V31

- IO-link interface for service and process data
- Programmable via DTM with PACTWARE
- Continuous distance value via IO-Link process data
- Selectable sound lobe width
- Synchronization options
- Temperature compensation
- Push-pull output

Single head system



### Dimensions

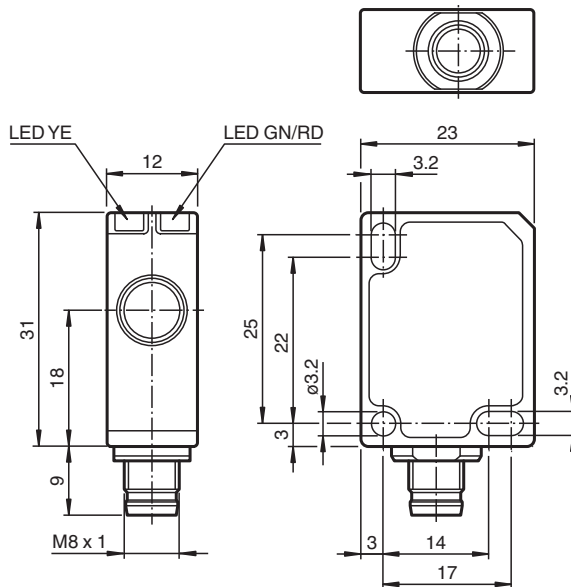

### Technical Data

#### General specifications

Sensing range	20 ... 250 mm
Adjustment range	25 ... 250 mm
Dead band	0 ... 20 mm
Standard target plate	10 mm x 10 mm
Transducer frequency	approx. 400 kHz
Response delay	minimum : 8 ms factory setting: 29 ms
Sensor cycle time	≥ 8 ms (factory setting) ; programmable to 60 s

#### Memory

Release date: 2021-01-07 Date of issue: 2021-02-05 Filename: 261242\_eng.pdf

Refer to "General Notes Relating to Pepperl+Fuchs Product Information".

Pepperl+Fuchs Group  
www.pepperl-fuchs.com

USA: +1 330 486 0001  
fa-info@us.pepperl-fuchs.com

Germany: +49 621 776 1111  
fa-info@de.pepperl-fuchs.com

Singapore: +65 6779 9091  
fa-info@sg.pepperl-fuchs.com

**PF** PEPPERL+FUCHS

## Technical Data

Non-volatile memory	EEPROM	
Write cycles	300000	
<b>Indicators/operating means</b>		
LED green	solid: Power on flashing: Standby mode or IO-Link communication	
LED yellow	solid: object in evaluation range flashing: switch point programming, object detected	
LED red	solid: error flashing: switch point programming, object not detected	
<b>Electrical specifications</b>		
Operating voltage	$U_B$	10 ... 30 V DC , ripple 10 % <sub>SS</sub>
No-load supply current	$I_0$	≤ 40 mA
Power consumption	$P_0$	≤ 400 mW
Time delay before availability	$t_v$	≤ 300 ms
<b>Interface</b>		
Interface type	IO-Link (via C/Q = Pin 4)	
Device profile	Smart Sensor	
Transfer rate	COM 2 (38.4 kBaud)	
IO-Link Revision	1.1	
Min. cycle time	2.3 ms	
Process data width	16 bit	
SIO mode support	yes	
Device ID	0x300300 (3146496)	
Compatible master port type	A	
<b>Input/Output</b>		
Input/output type	1 synchronization connection, bidirectional	
0 Level	0 ... 1 V	
1 Level	2.5 V ... $U_B$	
Input impedance	> 22 kΩ	
Output rated operating current	current source < 2.5 mA	
Pulse length	≥ 1 ms with external control, low active	
Synchronization frequency		
Common mode operation	≤ 141 Hz	
Multiplex operation	≤ 141 Hz / n , n = number of sensors , n ≤ 10	
<b>Output</b>		
Output type	1 push-pull (4 in 1) output, short-circuit protected, reverse polarity protected	
Rated operating current	$I_e$	100 mA , short-circuit/overload protected
Voltage drop	$U_d$	≤ 2.5 V
Repeat accuracy	≤ ± 0.1 % of full-scale value	
Switching frequency	$f$	factory setting: 20 Hz programmable max. 45 Hz
Range hysteresis	$H$	1 % of the adjusted operating range (default settings), programmable , min. 1 mm
Temperature influence	≤ ± 0.75 % of the end value (with temperature compensation) from 10 minutes after switching on the sensor ; 0,17 %/K (without temperature compensation)	
<b>Compliance with standards and directives</b>		
Standard conformity		
Standards	EN 60947-5-2:2007+A1:2012 IEC 60947-5-2:2007 + A1:2012 IEC 61131-9:2013	
<b>Approvals and certificates</b>		
UL approval	cULus Listed, Class 2 Power Source	
CCC approval	CCC approval / marking not required for products rated ≤36 V	
<b>Ambient conditions</b>		
Ambient temperature	-25 ... 70 °C (-13 ... 158 °F)	
Storage temperature	-40 ... 85 °C (-40 ... 185 °F)	

Release date: 2021-01-07 Date of issue: 2021-02-05 Filename: 261242\_eng.pdf

## Technical Data

Mechanical specifications	
Connection type	Connector plug M8 x 1 , 4-pin
Degree of protection	IP67
Material	
Housing	Polycarbonate
Transducer	epoxy resin/hollow glass sphere mixture; polyurethane foam
Installation position	any position
Mass	9 g
Tightening torque, fastening screws	max. 0.2 Nm
Factory settings	
Output	near switch point: 25 mm far switch point: 250 mm Output mode: Window mode Output logic: normally open
Beam width	wide

## Connection

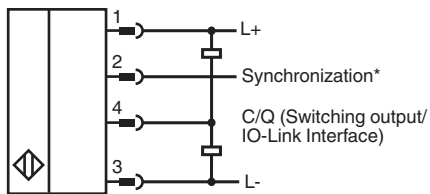

## Connection Assignment



Wire colors in accordance with EN 60947-5-2

1	BN	(brown)
2	WH	(white)
3	BU	(blue)
4	BK	(black)

Release date: 2021-01-07 Date of issue: 2021-02-05 Filename: 261242\_eng.pdf

## Characteristic Curve

### Characteristic response curve

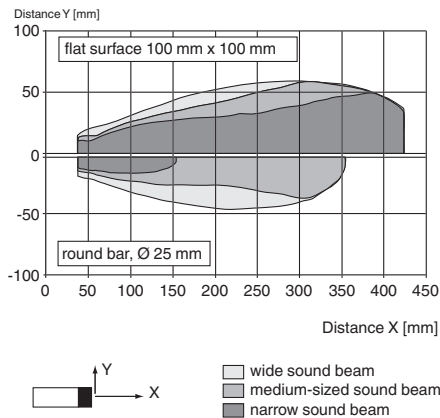

## Programming

### Switching output modes

1. Switch point mode

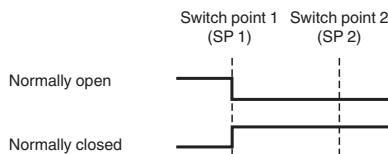

2. Window mode

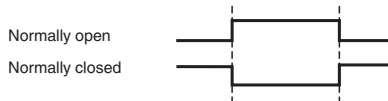

3. Hysteresis mode

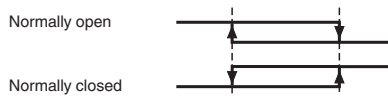

4. Retroreflective mode

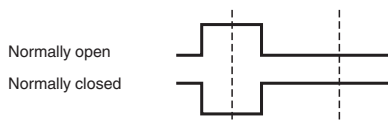

## Accessories

	<b>IO-Link-Master02-USB</b>	IO-Link master, supply via USB port or separate power supply, LED indicators, M12 plug for sensor connection
	<b>V31-GM-2M-PVC</b>	Female cordset single-ended M8 straight A-coded, 4-pin, PVC cable grey
	<b>V31-GM-1M-PVC-V1-G</b>	Cordset M8 socket straight to M12 plug straight A-coded, 4-pin, PVC cable grey
	<b>OMH-ML7-01</b>	Mounting aid for ML7 and ML8 series, Mounting bracket
	<b>OMH-ML7-02</b>	Mounting aid for ML7 and ML8 series, Mounting bracket

Release date: 2021-01-07 Date of issue: 2021-02-05 Filename: 261242\_eng.pdf

## Function

### Adjustment possibilities

The sensor features a switching output with 2 programmable switch points. Programming the switch points, the output mode, the output logic and the beam width can be done in two different ways:

- Using the sensor's programming button
- Using the IO-link interface of the sensor. This method requires an IO-link master (e.g. IO-link-Master02-USB) and the associated software. The download link is available on the product page for the sensor at [www.pepperl-fuchs.com](http://www.pepperl-fuchs.com).

### Synchronization

The sensor features a synchronization input for suppressing ultrasonic mutual interference („cross talk“).

The following synchronization modes are available:

1. Automatic multiplex mode.
2. Automatic common mode
3. Externally controlled synchronization

### Further Documentation

- For information on programming via programming button and synchronisation you may refer to the commissioning instruction.
- For detailed information on application and programming via IO-Link we provide a manual.