

Ultrasonic sensor

UC1500-F65-UE2R2-V15

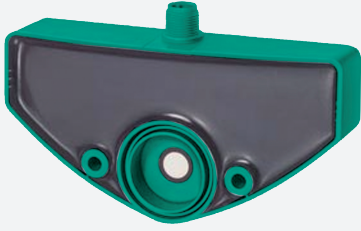

- Level indication
- 1 analog output, 0-10 V voltage source
- 1 switch output
- Programmable by means of Interface (see accessories) and SONPROG
- Synchronization options
- Temperature compensation



Dimensions

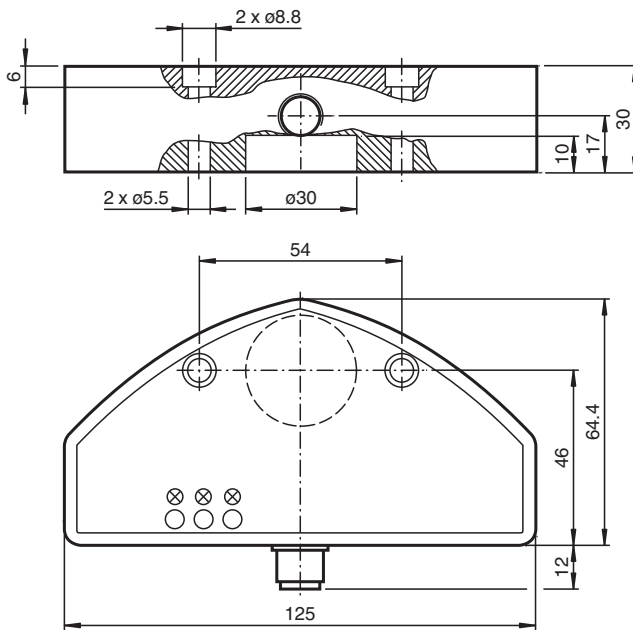

Technical Data

General specifications

Sensing range	200 ... 1500 mm
Adjustment range	200 ... 1500 mm
Dead band	0 ... 200 mm
Standard target plate	20 mm x 20 mm
Transducer frequency	approx. 200 kHz

Nominal ratings

Time delay before availability	t_v	250 ms
--------------------------------	-------	--------

Limit data

Permissible cable length	max. 300 m
--------------------------	------------

Release date: 2020-03-24 Date of issue: 2021-02-05 Filename: 235148_eng.pdf

Refer to "General Notes Relating to Pepperl+Fuchs Product Information".

Pepperl+Fuchs Group
www.pepperl-fuchs.com

USA: +1 330 486 0001
fa-info@us.pepperl-fuchs.com

Germany: +49 621 776 1111
fa-info@de.pepperl-fuchs.com

Singapore: +65 6779 9091
fa-info@sg.pepperl-fuchs.com

PEPPERL+FUCHS

Technical Data

Indicators/operating means		
LED green		Power on
LED yellow		solid: switching state switch output flashing: misadjustment
Electrical specifications		
Rated operating voltage	U_e	24 V DC
Operating voltage	U_B	15 ... 30 V (including ripple) In supply voltage interval 15 ... 20 V sensitivity reduced to 20% ... 0%
Ripple		≤ 10 %
No-load supply current	I_0	≤ 60 mA
Input		
Input type		1 Function input
Input voltage		\leq Operating voltage
Level		low level : 0 ... 3 V high level : ≥ 15 V
Switching output		
Output type		1 switch output PNP, NO
Default setting		200 ... 1500 mm
Operating current	I_L	≤ 300 mA , short-circuit/overload protected
Voltage drop		≤ 3 V
Analog output		
Output type		1 voltage output 0 ... 10 V , rising ramp
Default setting		200 ... 1500 mm
Linearity error		≤ 1.5 %
Load resistor		> 2 k Ω
Compliance with standards and directives		
Standard conformity		
Standards		EN 60947-5-2:2007+A1:2012 IEC 60947-5-2:2007 + A1:2012 EN 60947-5-7:2003 IEC 60947-5-7:2003
Approvals and certificates		
UL approval		cULus Listed, General Purpose
CCC approval		CCC approval / marking not required for products rated ≤ 36 V
Ambient conditions		
Ambient temperature		-25 ... 70 °C (-13 ... 158 °F)
Storage temperature		-40 ... 85 °C (-40 ... 185 °F)
Shock resistance		30 g , 11 ms period
Vibration resistance		10 ... 55 Hz , Amplitude ± 1 mm
Mechanical specifications		
Connection type		Connector plug M12 x 1 , 5-pin
Degree of protection		IP65
Material		
Housing		PBT
Transducer		epoxy resin/hollow glass sphere mixture; polyurethane foam
Installation position		any position
Mass		500 g

Connection

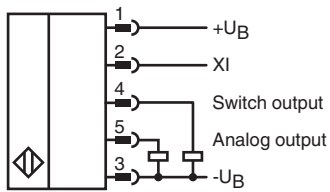

Connection Assignment

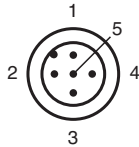

Wire colors in accordance with EN 60947-5-2

1	BN	(brown)
2	WH	(white)
3	BU	(blue)
4	BK	(black)
5	GY	(gray)

Characteristic Curve

Characteristic response curve

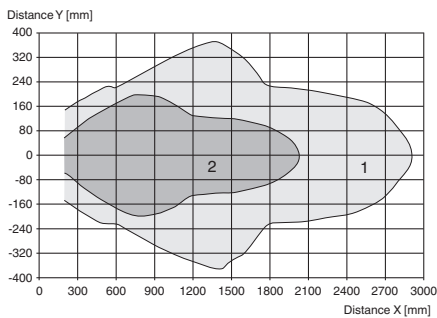

Curve 1: flat surface 100 mm x 100 mm
 Curve 2: round bar, Ø 25 mm



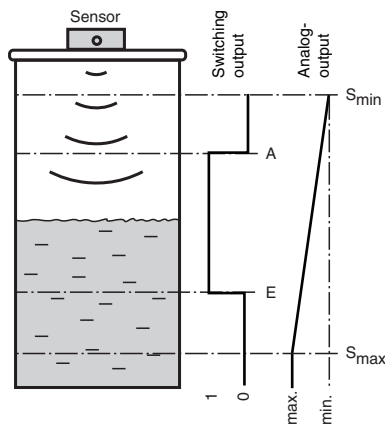

Release date: 2020-03-24 Date of issue: 2021-02-05 Filename: 235148_eng.pdf

Characteristic Curve

Function of the outputs



Accessories

	V15-G-2M-PUR	Female cordset single-ended M12 straight A-coded, 5-pin, PUR cable grey
	V15-G-2M-PVC	Female cordset single-ended M12 straight A-coded, 5-pin, PVC cable grey
	V15-W-2M-PVC	Female cordset single-ended M12 angled A-coded, 5-pin, PVC cable grey
	3RX4000-PF	PC interface

Additional Information

Application ranges

The design and function of this ultrasonic sensor make it ideal for filling level applications in small containers. The device has a switch output and an analogue output. With the switch output, a specific filling level in a tank can be signalled directly. The analogue output represents the current level as an analogue output variable.

Assembly and connection

All components are contained in an encapsulated housing. The ultrasonic converter is in a slightly recessed position in the housing. The integrated circumferential seal allows the sensor to be used directly as a closure with integrated filling level measurement. The tank opening must have a diameter of 26 mm. It can be mounted on the tank using 2 M5 screws. The electrical connection is based on a 5-pin device connector, M12 x 1. The connections are protected against reverse polarity, short circuits and overloads. Shielded cables are recommended if there is electrical interference.

Setting

As delivered, the switch-on and switch-off point, the measuring range limits and the averaging are fixed (see Technical data). They can subsequently be adapted to the application via SONPROG using the interface (see Accessories).

SONPROG

The following parameters can be changed via SONPROG:

- Measuring range limits S_{min} and S_{max}
- Switch-on and switch-off points (A, E)
- Blind zone
- Averaging

Special programming options are available on request.

Operation

The filling level of a container is detected within the detection range. When the filling level reaches the switch-on or switch-off point (E or A), the switch output reacts according to its setting. The switching statuses of the switch output are signalled by the yellow LEDs. If the level is between the switching points A and E, the output is active.

Filling levels between the measuring range limits (S_{min} , S_{max}) are displayed in the form of an analogue output signal at the analogue output. The analogue output delivers its minimum value at filling level S_{min} and its maximum value at filling level S_{max} . The characteristic between the two measuring range limits is linear.

Objects in the blind zone cause false signals. Install in such a way that the filling level cannot enter the blind zone.

Function input XI

The sensor is placed in standby mode by connecting a low level at the function input XI (blocked release). The sensors then performs no measurements. The outputs retain the most recent status. As soon as function input XI is disconnected from the low level or a high level is connected (release), the sensor resumes its normal function.

The function input XI can be used during operation for the synchronisation of multiple sensors. This can be done by connecting external signals, e.g. from a controller (external synchronisation) or by simply connecting the function inputs of all sensors to be synchronised (internal synchronisation).