



Ultrasonic sensor UB800-F12-U-V15

- Evaluation limits can be taught-in
- Selectable sound lobe width
- Synchronization options
- Very small unusable area
- Temperature compensation

Single head system



Dimensions

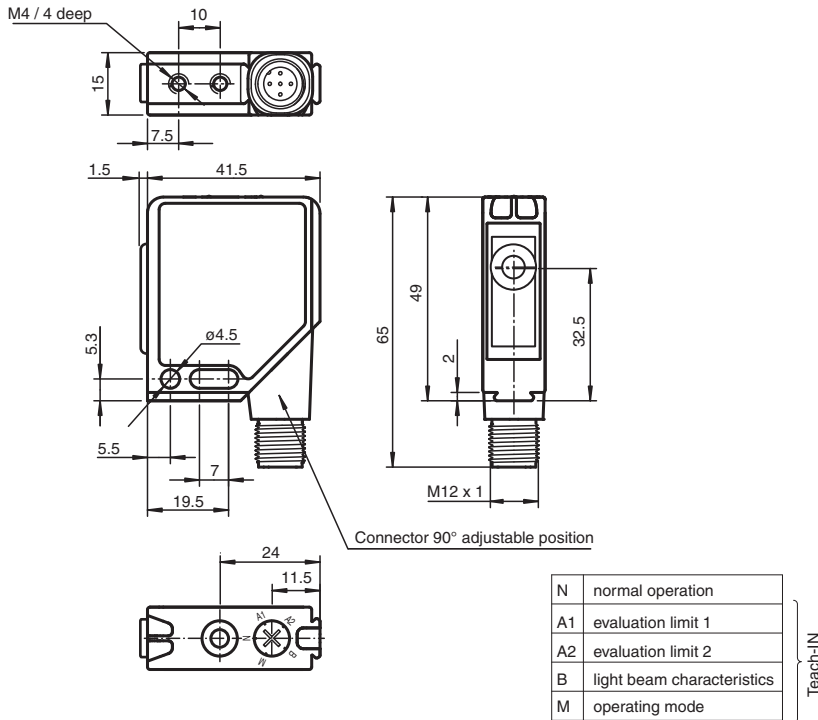

Technical Data

General specifications

Sensing range	30 ... 800 mm
Adjustment range	50 ... 800 mm
Dead band	0 ... 30 mm
Standard target plate	100 mm x 100 mm
Transducer frequency	approx. 310 kHz
Response delay	approx. 100 ms

Indicators/operating means

LED green	Operating display
LED yellow	Evaluation range indicator, Ready for programming

Release date: 2020-05-23 Date of issue: 2021-02-05 Filename: 202068_eng.pdf

Refer to "General Notes Relating to Pepperl+Fuchs Product Information".

Pepperl+Fuchs Group
www.pepperl-fuchs.com

USA: +1 330 486 0001
fa-info@us.pepperl-fuchs.com

Germany: +49 621 776 1111
fa-info@de.pepperl-fuchs.com

Singapore: +65 6779 9091
fa-info@sg.pepperl-fuchs.com

PF PEPPERL+FUCHS

Technical Data

LED red		Ready for programming, Fault
Electrical specifications		
Operating voltage	U_B	12 ... 30 V DC
No-load supply current	I_0	≤ 30 mA
Input/Output		
Synchronization		1 synchronous connection, bi-directional 0-level: $-U_B \dots +1 \text{ V}$ 1-level: $+4 \text{ V} \dots +U_B$ input impedance: > 12 kΩ synchronization pulse: ≥ 100 μs, synchronization interpulse period: ≥ 2 ms
Synchronization frequency		
Common mode operation		max. 45 Hz
Multiplex operation		≤ 45/n Hz, n = number of sensors
Input		
Input type		1 program input Switching distance 1: $-U_B \dots +1 \text{ V}$, Switching distance 2: $+3 \text{ V} \dots +U_B$ Input impedance: > 10 kΩ
Pulse length		≥ 1 s
Output		
Output type		1 analog output 0 ... 10 V
Default setting		evaluation limit A1: 50 mm , evaluation limit A2: 800 mm , wide sound lobe , rising ramp
Repeat accuracy		≤ 1 %
Load impedance		≥ 500 Ohm
Temperature influence		± 1.5 % of full-scale value
Compliance with standards and directives		
Standard conformity		
Standards		EN 60947-5-2:2007+A1:2012 IEC 60947-5-2:2007 + A1:2012 EN 60947-5-7:2003 IEC 60947-5-7:2003
Approvals and certificates		
UL approval		cULus Listed, General Purpose
CSA approval		cCSAus Listed, General Purpose
CCC approval		CCC approval / marking not required for products rated ≤36 V
Ambient conditions		
Ambient temperature		-15 ... 70 °C (5 ... 158 °F)
Storage temperature		-40 ... 85 °C (-40 ... 185 °F)
Mechanical specifications		
Connection type		Connector M12 x 1 , 5-pin
Degree of protection		IP54
Material		
Housing		Frame: nickel plated, die cast zinc, Laterals: glass-fiber reinforced plastic PC
Transducer		epoxy resin/hollow glass sphere mixture; foam polyurethane, cover PBT
Mass		60 g

Connection

Standard symbol/Connections:
(version U)

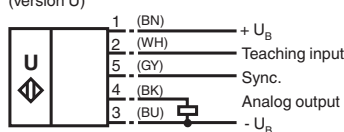

Core colours in accordance with EN 60947-5-2.

Release date: 2020-05-23 Date of issue: 2021-02-05 Filename: 202068_eng.pdf

Connection Assignment

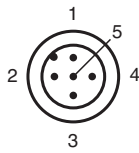

Wire colors in accordance with EN 60947-5-2

1	BN	(brown)
2	WH	(white)
3	BU	(blue)
4	BK	(black)
5	GY	(gray)

Characteristic Curve

Characteristic response curve

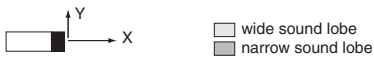
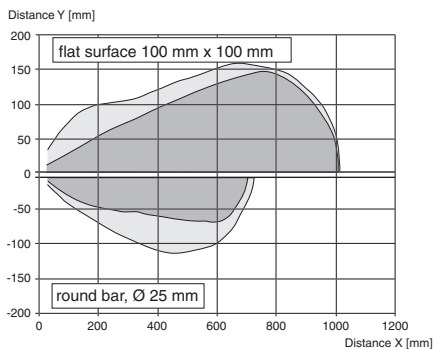

Analogue output programming

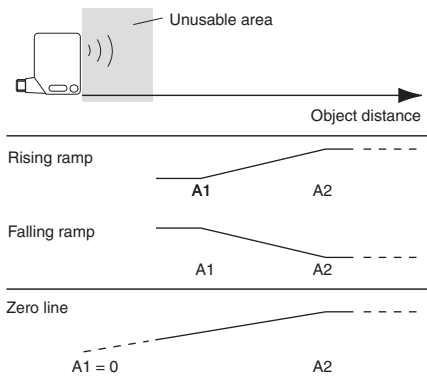

Accessories

	OMH-K01	dove tail mounting clamp
	OMH-K02	dove tail mounting clamp
	OMH-K03	dove tail mounting clamp

Release date: 2020-05-23 Date of issue: 2021-02-05 Filename: 202068_eng.pdf

Refer to "General Notes Relating to Pepperl+Fuchs Product Information".

Pepperl+Fuchs Group
www.pepperl-fuchs.com





USA: +1 330 486 0001
fa-info@us.pepperl-fuchs.com

Germany: +49 621 776 1111
fa-info@de.pepperl-fuchs.com

Singapore: +65 6779 9091
fa-info@sg.pepperl-fuchs.com

PEPPERL+FUCHS

Accessories

	OMH-01	Mounting aid for round steel ø 12 mm or sheet 1.5 mm ... 3 mm
	OMH-06	Mounting aid for round steel ø 12 mm or sheet 1.5 mm ... 3 mm
	OMH-MLV12-HWG	Mounting bracket for series MLV12 sensors
	OMH-MLV12-HWK	Mounting bracket for series MLV12 sensors
	V15-G-2M-PVC	Female cordset single-ended M12 straight A-coded, 5-pin, PVC cable grey

Release date: 2020-05-23 Date of issue: 2021-02-05 Filename: 202068_eng.pdf





Refer to "General Notes Relating to Pepperl+Fuchs Product Information".

Pepperl+Fuchs Group
www.pepperl-fuchs.com

USA: +1 330 486 0001
fa-info@us.pepperl-fuchs.com

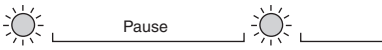
Germany: +49 621 776 1111
fa-info@de.pepperl-fuchs.com

Singapore: +65 6779 9091
fa-info@sg.pepperl-fuchs.com

Characteristic	Flashing sequence of the green LED	T-Button
Narrow beam		
Medium beam		
Broad beam		

- Return the selector switch to position N when the desired beam breadth is indicated.

Note: Acceptance of the ultrasonic beam breadth into the permanent memory of the sensor does not take place until the selector switch is set to N. If this acceptance does not take place within the 5 minute time window, the sensor continues its operation with an unchanged ultrasonic beam breadth and the red and yellow LEDs flash.

Synchronisation

A synchronisation connection is provided for the suppression of mutual interference. If this is unused, or connected to 0V, then the sensor operates with an internally generated clock-pulse rate. The synchronisation of a number of sensors can be achieved by the following means.

External synchronisation:

The sensor can be synchronised by the external application of a square-wave voltage. A synchronisation pulse at the synchronisation input leads to the execution of a measuring cycle. The pulse width must be greater than 1.2 ms. The measuring cycle starts with the falling ramp. A low level > 1 s or an open synchronisation input leads to the normal operation of the sensor. A high level at the synchronisation input deactivates the sensor.

Two operating modes are possible.

- A number of sensors are triggered by the same synchronisation signal. The sensors operate in common mode.
- The synchronisation pulses are fed cyclically to one sensor at a time. The sensors operate in multiplex mode.

Self-synchronisation:

The synchronisation connections of up to 5 sensors are connected together to provide the option of self-synchronisation. When the operating voltage is switched on these sensors operate in multiplex mode. The switch-in delay increases depending on the number of sensors to be synchronised. Synchronisation cannot take place during teach-in and vice-versa. The sensors must be operated unsynchronised for the teaching-in of the switch points.

Note:

If the synchronisation option is not used, then the synchronisation input is connected to earth (0V) or the sensor is operated with a V1 connection cable (4-pole).

Release date: 2020-05-23 Date of issue: 2021-02-05 Filename: 202088_eng.pdf