

# Ultrasonic sensor

## UB2000-F54-E4-V15



- Switch output
- 5 different output functions can be set
- Program input
- Synchronization options
- Deactivation option
- Temperature compensation

Single head system



### Dimensions

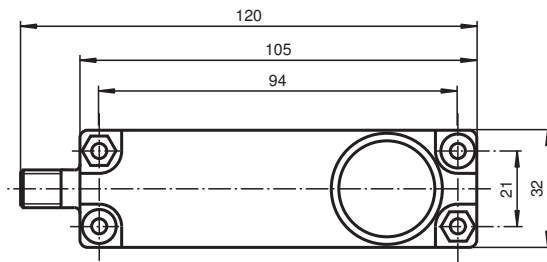

Bore hole and countersinking for screws/hexagon M4

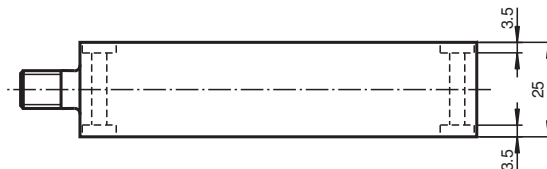

### Technical Data

#### General specifications

Sensing range	80 ... 2000 mm
Adjustment range	100 ... 2000 mm
Dead band	0 ... 80 mm
Standard target plate	100 mm x 100 mm
Transducer frequency	approx. 175 kHz
Response delay	≤ 150 ms

#### Indicators/operating means

LED green	solid green: monitoring system green flashing: program function
-----------	--

Release date: 2020-05-23 Date of issue: 2021-02-05 Filename: 108161\_eng.pdf

Refer to "General Notes Relating to Pepperl+Fuchs Product Information".

Pepperl+Fuchs Group  
www.pepperl-fuchs.com

USA: +1 330 486 0001  
fa-info@us.pepperl-fuchs.com

Germany: +49 621 776 1111  
fa-info@de.pepperl-fuchs.com

Singapore: +65 6779 9091  
fa-info@sg.pepperl-fuchs.com

**PF** PEPPERL+FUCHS

## Technical Data

LED yellow		indication of the switching state flashing: program function object detected
LED red		flashing: normal mode: error Program function: no object detected permanently: Program mode, object uncertain
<b>Electrical specifications</b>		
Operating voltage	$U_B$	10 ... 30 V DC , ripple 10 % <sub>SS</sub>
No-load supply current	$I_0$	≤ 55 mA
<b>Input/Output</b>		
Synchronization		1 synchronous input 0-level: $-U_B \dots +1 \text{ V}$ 1-level: $+4 \text{ V} \dots +U_B$ input impedance: > 12 KOhm synchronization pulse: 0,1 ... 28 ms
Synchronization frequency		
Common mode operation		max. 33 Hz
Multiplex operation		≤ 33 / n Hz, n = number of sensors
<b>Input</b>		
Input type		1 program input, switching point A1: $-U_B \dots +1 \text{ V}$ , switching point A2: $+4 \text{ V} \dots +U_B$ input impedance: > 4.7 kΩ, program pulse: ≥ 1 s
<b>Output</b>		
Output type		1 switch output E4, NPN, NO/NC
Rated operating current	$I_e$	200 mA , short-circuit/overload protected
Voltage drop	$U_d$	≤ 3 V
Repeat accuracy		≤ 1 % of full-scale value
Switching frequency	f	max. 3 Hz
Range hysteresis	H	≤ 1 % of the set operating distance
Temperature influence		± 1.5 % of full-scale value
<b>Compliance with standards and directives</b>		
Standard conformity		
Standards		EN 60947-5-2:2007+A1:2012 IEC 60947-5-2:2007 + A1:2012
<b>Approvals and certificates</b>		
UL approval		cULus Listed, General Purpose
CSA approval		cCSAus Listed, General Purpose
CCC approval		CCC approval / marking not required for products rated ≤36 V
<b>Ambient conditions</b>		
Ambient temperature		-25 ... 70 °C (-13 ... 158 °F)
Storage temperature		-40 ... 85 °C (-40 ... 185 °F)
<b>Mechanical specifications</b>		
Connection type		Connector M12 x 1 , 5-pin
Degree of protection		IP65
Material		
Housing		ABS
Transducer		epoxy resin/hollow glass sphere mixture; polyurethane foam
Mass		100 g

## Connection

**Standard symbol/Connections:**  
(version E4, npn)

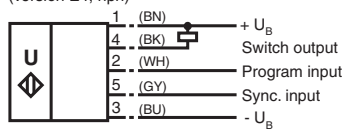

Wire colors in accordance with EN 60947-5-2.

## Connection Assignment

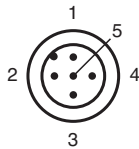

Wire colors in accordance with EN 60947-5-2

1		BN	(brown)
2		WH	(white)
3		BU	(blue)
4		BK	(black)
5		GY	(gray)

## Characteristic Curve

### Characteristic response curve

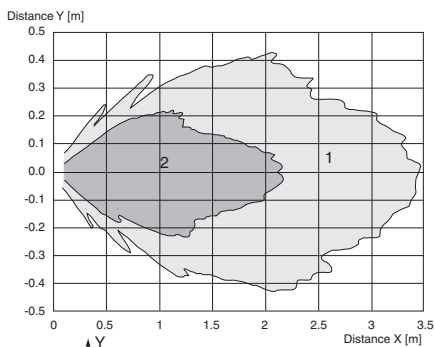

Curve 1: flat surface 100 mm x 100 mm  
Curve 2: round bar, Ø 25 mm



Release date: 2020-05-23 Date of issue: 2021-02-05 Filename: 108161\_eng.pdf

## Programming

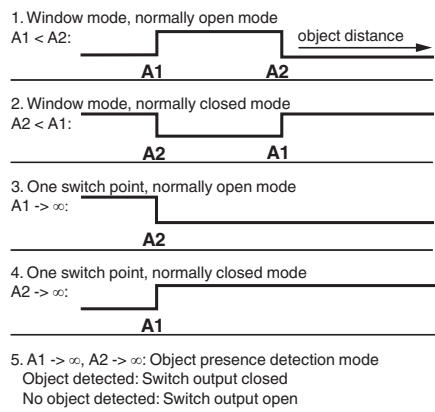
### Programmable output modes



## Accessories

	<b>UB-PROG2</b>	Programming unit
	<b>V15-G-2M-PVC</b>	Female cordset single-ended M12 straight A-coded, 5-pin, PVC cable grey

Release date: 2020-05-23 Date of issue: 2021-02-05 Filename: 108161\_eng.pdf

## Additional Information

### Synchronisation

The sensor features a synchronisation input for the suppression of mutual interference. If this input is not used, the sensor will operate using an internally generated clock rate. The synchronisation of multiple sensors can be realised as follows:

#### External synchronisation

The sensor can be synchronised by the external application of a square wave voltage. A synchronisation pulse at the synchronisation input starts a measuring cycle. The pulse must have a duration greater than 100  $\mu$ s. The measuring cycle starts with the falling edge of a synchronisation pulse. A low level > 1 s or an open synchronisation input will result in the normal operation of the sensor. A high level at the synchronisation input disables the sensor.

Two operating modes are available

1. Multiple sensors can be controlled by the same synchronisation signal. The sensors are synchronised.
2. The synchronisation pulses are sent cyclically to individual sensors. The sensors operate in multiplex mode.

#### Internal synchronisation

The synchronisation connections of up to 5 sensors capable of internal synchronisation are connected to one another. When power is applied, these sensors will operate in multiplex mode. The response delay increases according to the number of sensors to be synchronised. Synchronisation cannot be performed during TEACH-IN and vice versa. The sensors must be operated in an unsynchronised manner to teach the switching point.

#### Note:

If the option for synchronisation is not used, the synchronisation input has to be connected to ground (0V) or the sensor has to be operated via a V1 cable connector (4-pin).

### Adjusting of switching points

The ultrasonic sensor features a switch output with two teachable switching points. These are set by applying the supply voltage  $-U_B$  or  $+U_B$  to the TEACH-IN input. The supply voltage must be applied to the TEACH-IN input for at least 1 s. LEDs indicate whether the sensor has recognised the target during the TEACH-IN procedure. Switching point A1 is taught with  $-U_B$ , A2 with  $+U_B$ .

Five different output functions can be set

1. Window mode, normally-open function
2. Window mode, normally-closed function
3. One switching point, normally-open function
4. One switching point, normally-closed function
5. Detection of object presence

#### TEACH-IN window mode, normally-open function

- Set target to near switching point
- TEACH-IN switching point A1 with  $-U_B$
- Set target to far switching point
- TEACH-IN switching point A2 with  $+U_B$

#### TEACH-IN window mode, normally-closed function

- Set target to near switching point
- TEACH-IN switching point A2 with  $+U_B$
- Set target to far switching point
- TEACH-IN switching point A1 with  $-U_B$

#### TEACH-IN one switching point, normally-open function

- Set target to near switching point
- TEACH-IN switching point A2 with  $+U_B$
- Cover sensor with hand or remove all objects from sensing range
- TEACH-IN switching point A1 with  $-U_B$

#### TEACH-IN one switching point, normally-closed function

- Set target to near switching point
- TEACH-IN switching point A1 with  $-U_B$
- Cover sensor with hand or remove all objects from sensing range
- TEACH-IN switching point A2 with  $+U_B$

#### TEACH-IN detection of object presence

- Cover sensor with hand or remove all objects from sensing range
- TEACH-IN switching point A1 with  $-U_B$
- TEACH-IN switching point A2 with  $+U_B$

### Default setting of switching points

A1 = unusable area

A2 = nominal sensing range

**LED Displays**

Displays in dependence on operating mode	Red LED	Yellow LED	Green LED
<b>TEACH-IN switching point:</b>			
Object detected	off	flashes	flashes
No object detected	flashes	off	flashes
Object uncertain (TEACH-IN invalid)	on	off	flashes
Normal operation	off	switching state	on
Fault	flashes	previous state	off

Release date: 2020-05-23 Date of issue: 2021-02-05 Filename: 108161\_eng.pdf